



MOTORCYCLE PISTONS

TECH TIPS & INSTALLATION

Hypereutectic Motorcycle Application

Your KB Hypereutectic motorcycle pistons are made from a high silicon aluminum alloy. Hypereutectic alloys have less thermal expansion and lower thermal conductivity than a typical cast or forged piston alloy. In addition to greater thermal properties, Hypereutectic alloys have 16% silicon which gives superior wear properties. **The low thermal conductivity of this alloy requires engines running hypereutectic pistons to reduce total ignition timing 2 to 4 degrees.**

KB Forged Motorcycle Application

KB's Forged motorcycle line is supplied in 4032 alloy in new lightweight designs. **It is important to remember that specifications for hypereutectic and forged applications be kept separate.**

Clearances

MINIMUM PISTON TO WALL CLEARANCE

The spreadsheet below is for general clearance guidelines for KB Pistons, but final sizing needs to be based on your application and conditions.

Hypereutectic	Bore Size	Forged	Bore Size	
	Under 4.00"		Under 4.125"	4.125" & Above
Aluminum Cyl w/ Steel Sleeve	.0015"	Aluminum Cyl w/ Steel Sleeve	* .0025"	* .0030"
Cast Iron Cylinder	.0020"	Cast Iron Cylinder	* .0025"	* N/A

Special note on STANDARD size pistons: .001" less clearance is built into the piston to allow honing of a good STANDARD bore cyl. New cylinders must be checked for proper wall clearance and may require slight honing.

*Standard Coated Skirts. Not including Line2Line coating option: Under 4.125" - .0020" / 4.125" & Above - .0025"

IMPORTANT!!! Ring end gaps MUST be checked for proper gap opening.

Multiply bore size by the ring end gap factor listed below for your application (i.e. 3.498" X .0065" = .022" gap)

MINIMUM TOP RING END GAP FACTORS

Application	Hypereutectic	Forged
Stock / Light Bike	.0065"	.004"
Hi Comp	.008"	.0055"
Boosted	.008"	.006"

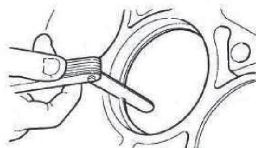

MINIMUM SECOND RING END GAP FACTORS

All	.004"	.004"
-----	-------	-------

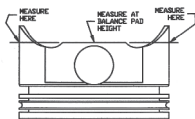

KB Hypereutectic and Premium Forged Motorcycle Pistons Nominal Clearances

The following standards are used on all KB Hypereutectic and Premium forged motorcycle non-coated pistons. All KB motorcycle pistons come with clearance built into the piston. An example is a 3.498" hypereutectic piston at .010" over would have the cylinder bored to 3.508" and we would supply the piston at 3.5065" for a clearance of .0015". **Final piston clearance should be based solely on the demands of your application. Consideration should be given to such things as components being used, demands of the application, climatic conditions, fuel, desired compression ratio, just to mention a few. Typically, additional clearance is honed into the cylinder if more demanding applications are intended, and there may be cases where reduced clearance is acceptable. The chart above is for general clearance guidelines, but final sizing needs to be made based on your conditions. Hypereutectic and forged applications have different minimum clearance requirements.**

Calculating Compression Ratios

When calculating compression ratios, KB treats a **dish** designed piston as a positive number. This is because a **dish** adds volume to the cylinder head. All KB **dish** pistons receive a positive cc volume. The reverse is true for all **dome** style pistons. Since the **dome** removes volume from the cylinder head we give all **domes** a negative cc volume. Remember this when calculating compression using the KB calculator on our website uempistons.com.

United Engine & Machine Co. Inc.

1040 Corbett St. — Carson City, NV 89706

PHONE: 800-648-7970 or 775-882-7790 — FAX: 775-882-7773

EMAIL: tech@uempistons.com — WEB: www.uempistons.com

TECH TIPS & INSTALLATION, *continued*

Spiral lock rings – used in all series:

1. Spring the lock about $\frac{1}{2}$ " to $\frac{3}{4}$ " to get your thumb between the coils.
2. Insert tang into groove. Slightly twist your wrist towards the groove angling the lock downward into the groove.
3. Using a small flat screwdriver push down on the lock to push it into the groove. Continue in a circular rotation. Do not try to spin the lock in.

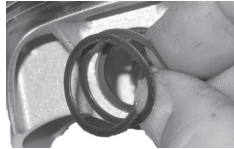
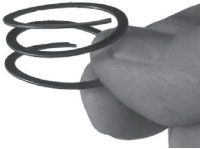

Pin Lubrication and Installation

1. Use a high quality engine assembly lube such as Torco between the pin and pin bore. Failure to properly lubricate may result in pin seizure.
2. Do not use grease when lubricating the pin bore. Grease acts as a dam and prevents oil from getting to the pin.
3. **Special note for Sportster, Pan, Knuckle and Shovelhead:** Both .791" and .792" diameter pins were used in these engines. Check pin fit in rod bushing before installing piston. It should slide in freely just like in the piston. If it does not the rod bushing will need to be reamed to .0006" - .0008" clearance.

Installation Rings

Top Two: Always use a ring expander tool to stretch rings over the piston, expand ring only enough to get ring over piston.

NEVER SPIRAL COMPRESSION RINGS ON



Oil Support Rail

Application where the wrist pin is intersecting the oil groove require an Oil Support Rail to bridge the gap the wrist pin cut out has made.

All three of the oil control rings are then installed on top of the Support Rail.

Special Note: The raised dimple on the Support Rail is positioned down and indexed in the open area of the wrist pin cut out.

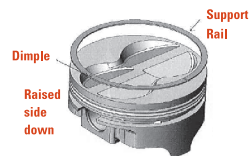

Offset Pin Orientation

All FORGED pistons are supplied with offset wrist pins. Offset pins are designed to help control piston slap noise. The short offset side must always be towards the thrust face side of the engine which is to the rear of the bike.

Note: Arrows are showing direction of thrust side only. Arrow on piston goes towards the front of the bike.

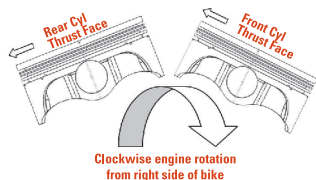

Helpful Dimensions

	Case Deck Hgt	Cylinder Length Gasket to Gasket	Rod Length
74" Panhead	5.375"	5.330" + .200" Fire Ring	7.440"
80" Shovelhead	5.375"	5.330" + .200" Fire Ring	7.440"
Ironhead Sportster	5.070"	5.330" + .167" Fire Ring	* 7.440"
Evo Sportster	5.375"	4.650"	6.926"
80" EVO	5.375"	5.550"	7.440"
Twin Cam 88"-110"	6.000"	4.937"	7.667"

*Early Ironhead 7.475"

Installation of 883cc to 1200cc Conversion and 1340cc Pop-up

These pistons have asymmetrical valve reliefs and head designs. Put the intakes to the center of the engine and the quench toward the carburetor.

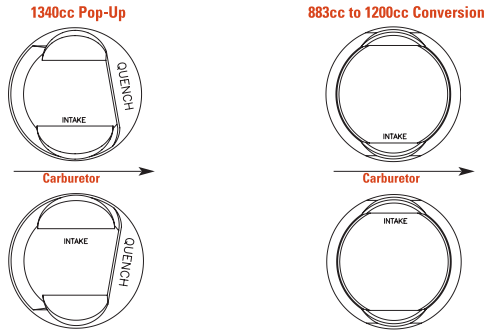

Installation of Sportster Domes

The pistons are marked front and rear. Intakes toward the middle of the engine. Dome toward the carburetor.

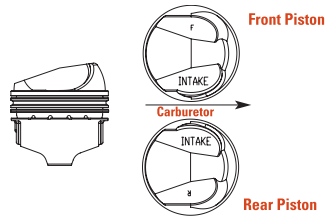

Installation of Motorcycle Piston with Symmetrical and Asymmetrical Valve Reliefs

When installing KB Motorcycle Pistons that have **symmetrical** valve reliefs, the piston can be turned so either valve is pointing toward the center of the engine. The piston can be fit in either the front or rear cylinder.

If the piston has **symmetrical** valve reliefs but has a relief cut in the skirt tip, the cut relief must be oriented toward the center of the engine. The piston can be fit in either the front or rear cylinder.

Piston skirt tip clearance should always be checked.

When installing KB Motorcycle Pistons that have **asymmetrical** valve reliefs (intake larger than exhaust), the intake should always be oriented toward the center of the engine. The piston can be in either the front or rear cylinder.

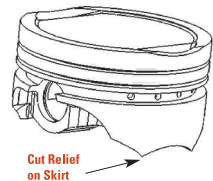

Symmetrical Valve Relief

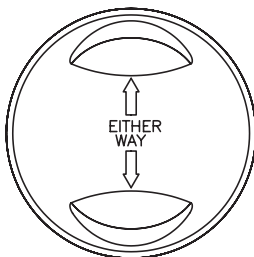

Asymmetrical Valve Relief

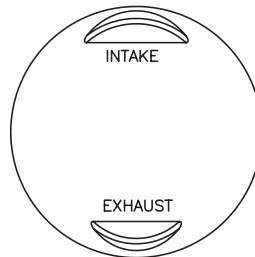

SHOVELHEAD INSTALLATION TIPS

80" thru 98" Shovelhead

Stock and Big Bore Oil Drain Back Hole Clearance Check.

- Step 1** Measure from top of cylinder to top of oil drain back hole in cylinder. _____
- Step 2** Install piston without rings and place cylinder with base gasket over piston then rotate to Bottom Dead Center. _____
- Step 3** Measure from top of cylinder to top of outer step on piston. _____
- Step 4** With piston back out of cylinder, measure from top of outer step on piston to bottom of oil ring groove. _____
- Step 5** Add 3 and 4 together. _____
- Step 6** Subtract 1 from 5; this will be the clearance number. _____
- Note** If the oil ring is allowed to go down into the drain back hole it may get overloaded with oil that it can not control which will result in high oil consumption.

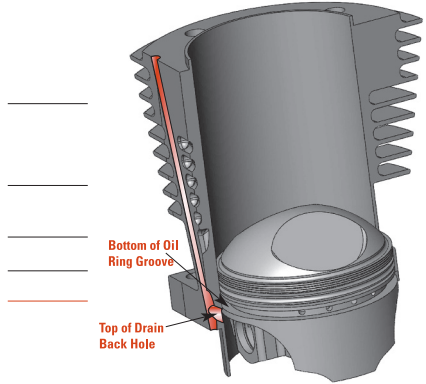

Calculating Deck Clearance and Required Piston Compression Height

1. Measure cylinder length, gasket surface to gasket surface. _____
2. Fire ring height, typical is .200" _____
3. Base gasket thickness. _____
4. Deck Height, centerline of crank to cylinder gasket surface. Stock Shovelhead is 5.375" _____
5. Add 1, 2, 3 and 4 (this is your Case/Cylinder stack-up) _____
6. Half stroke _____
7. Rod length, stock Shovelhead rod is 7.440" _____
8. Piston compression height, centerline of pin to outer step on top of piston. (you will find the comp. hgt. on KB pistons listed in the catalog in the header of each listing) _____
9. Add 6, 7 and 8 (this is your crank, rod and piston stack-up) _____
10. Subtract 9 from 5. (this is your deck clearance.) _____

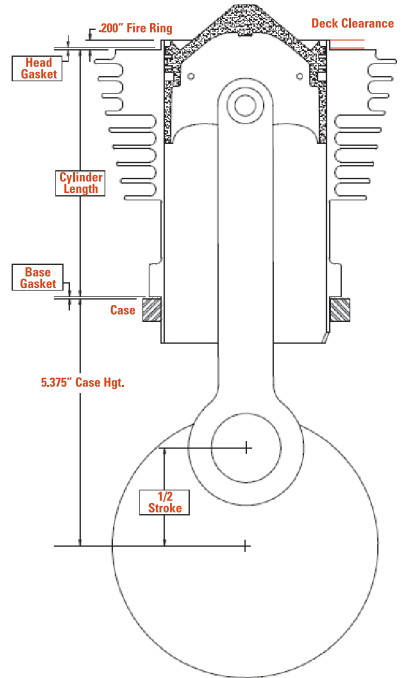

For easy compression ratio calculator go to www.uempistons.com then TOOLS to calculator.
Or call the Tech line at 800-648-7970 ex 3.

WARRANTY DISCLAIMER

Due to the nature of performance applications, the parts sold by United Engine & Machine Co. Inc. are sold without any express warranty or any implied warranty of merchantability or fitness for a particular purpose. UEM shall not, under any circumstances, be liable for any special, incidental or consequential damages, including, but not limited to damage, or loss of profits or revenue, cost of purchased or replacement goods, or claims of customers of the purchaser, which may arise and/or result from sale, installation or use of these parts.

UEM reserves the right to make product improvements or changes without notice and without incurring liability with respect to similar products previously manufactured.

The information contained in this instruction should not be considered absolute. Final decisions concerning the installation and use of these products are ultimately the responsibility of the customer. UEM makes no guarantee of warranty on emissions.