



• Thank you for purchasing Koso's HD-05 meter for Harley-Davidson®. This product is a multifunction meter that has a digital liquid crystal display (LCD) with a backlight design, and is easy to install. Before using, please read the instructions carefully and retain them for future reference.

⚠ Notice

- To avoid a short circuit from occurring do not pull or modify the wires during installation.
- Any damages caused by faulty installation shall be imputed to the users.
- Opening and disassembling this unit will void any warranty.
- Maintenance and repairs should be executed by our professionals only.

○ Symbol description:

NOTE You could get the installation details from the information behind the mark.

⚠ Some processes must be followed to avoid the affection caused by wrong installation.

⚠ Warning! Some procedures must be followed in order to avoid damages from occurring to yourself and others.

⚠ Caution! Some procedures must be followed in order to avoid damages from occurring to the vehicle.

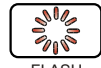

FLASH



LIGHT ON



HOLD THE
BUTTON ONE
TIME



HOLD THE
BUTTON 3
SECONDS

1 Accessories

1 LCD Meter X1



NOTE Contact your local distributor if the items received are not the same as the items listed above.

2 Installation diagram

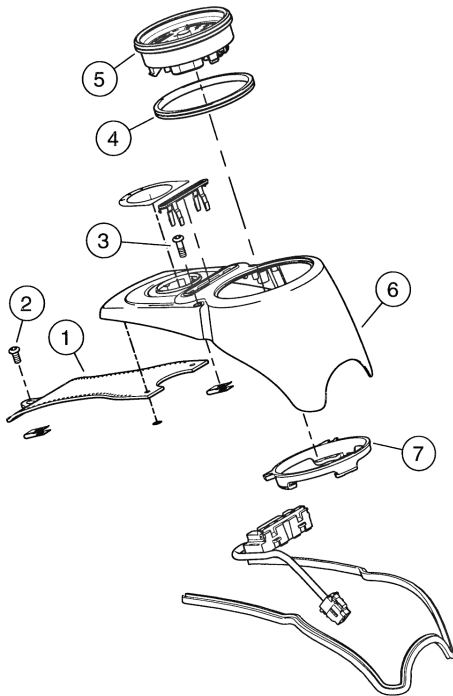

- 1. Trim
- 2. Screw
- 3. Screw
- 4. Gasket
- 5. Speedometer
- 6. Console
- 7. Back clamp

NOTE For installation on other follow the procedure according to your Harley-Davidson Service Manual.

3-1 Overview

Tachometer
 ●Display Range : 0 ~ 8,000 RPM

Indicator
 ●RPM shift light ●ABS light
 ●Low fuel warning light
 ●Engine check light
 ●Battery discharge light
 ●Security light
 ●Cruise light

Gear meter
 ●Display range : off, highest gear, N and highest gear, show all (N / 1 ~ 6)

Fuel meter
 ●Display Range : 6 Levels

Odometer
 ●Display range : 0 ~ 999,999 km (miles) return to zero upon exceeding
 ●Display unit : 1 km (mile)

Distance meter A,B
 ●Display range : 0 ~ 9,999.9 km (miles) returns to zero upon exceed
 ●Display unit : 0.1km (mile)



Speedometer
 ●Display range : 0 ~ 360 km/h (0 ~ 225 MPH)
 ●Display unit : 1 km/h (MPH)

Mileage maintenance user settings (closable)
 ●Display range : user adjustable (500 ~ 16,000 km / 300 ~ 10,000 miles) ~ -999 km (miles), automatic decrease according to the increase of total mileage.
 ●Display unit : 1 km (mile)

Remaining mileage
 ●Display range : 0 ~ 9,999 km (miles), when mileage is lower than 16 km (10 miles) will display LO RNG

Average fuel consumption
 ●Display range : L/100 km, km/L, MPG (US-spec.), MPG (UK-spec.)

Time
 ●Display range : 12 / 24 hour format

Engine temperature
 ●Setting range : -40 ~ 300°C (-40 ~ 572 °F)

Voltmeter
 ●Display range : 8~18V

3-2 Features and settings description

●Speedometer	Display range : 0 ~360 km/h (0 ~ 225 MPH) switchable Display unit : 1 km/h (MPH)	○Average fuel consumption	Display range : OFF \ L/100 km \ km/L \ MPG (US spec.) \ MPG (UK spec)
○Display interval	<0.5 second	●Clock	Setting range : 12 / 24 hour format
○Internal and external odometer	Display range : 0 ~ 999,999 km (miles) return to zero upon exceeding Display unit : 1 km (mile)	●Voltmeter	Display range : 8 ~ 18 V
○Trip meter A,B	Display range : 0 ~ 9,999.9 km (miles) returns to zero upon exceeding Display unit : 0.1 km (mile)	●Backlight brightness	Setting range : 1 / 5 (darkest) ~ 5 / 5 (brightest)
○Tire circumference	Setting range : 50 ~ 210 % Setting unit : 1 %	○Backlight color	Setting range : red, orange, yellow, green, blue, indigo, purple, white
●Gear meter	Display range : off, highest gear, N and highest gear, show all (N / 1 ~ 6)	●Mileage maintenance	Setting range : Off, 500 ~ 16,000 km (300 ~ 10,000 mile) Setting unit : 100 km (miles)
●Tachometer	Display Range : 0 ~ 8,000 RPM	●Operating voltage	DC 12 V
○RPM shift light	Setting range : 2,000 ~ 8,000 RPM Warning lights on when exceed setting value (including). Setting unit : 100 RPM	●Temperature range	-10 ~ +60 °C
○Max. RPM warning mode	Setting range : F-OFF (Lit.), F-ON (blink)	●Specifications	JIS D 0203 (S2)
●Engine temperature	Setting range : -40 ~ 300 °C (-40 ~ 572 °F)	●Meter size	D117 X 45 mm
●Fuel meter	Display range : off, Dyna	●Meter weight	208.5 grams
○Fuel tank volume	Setting range : OFF/ 1.0 ~ 9.9 US gallons	●Indication light	RPM shift light (Red light) ● Low fuel warning light (Yellow light) ☼ Engine check light (Yellow light) ⚠ Battery discharge light (Red light) 🔋 Security light (Red light) 🔒 Cruise light (Orange / Green light) 🚦 ABS light (Yellow light) 🚘

NOTE Design and specification may change without further notice.

3-3 Application list

- Dyna 2012+
 - Softail 2011+ (Expect Softail 2.0)
- [Fuel Type] Please set as CUS (user define), and follow the procedure to learn the fuel position for 0% (E), 33%, 66%, and 100% (F).

3-4 Main menu functions

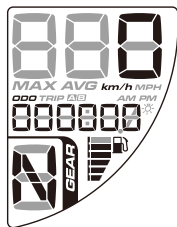

- In the total mileage screen, press the **button once** to switch to Trip A screen.
- When the engine switch is OFF, hold the **button for 3 seconds** to enter into the setting screen.

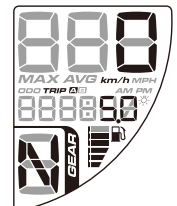

- Trip A screen, press the **button once** to switch to Trip B screen.
- Hold the **button for 3 seconds** to clear the Trip A recordings.

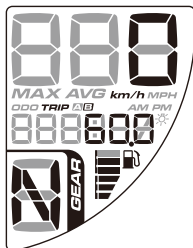

- Trip B screen, press the **button once** to switch to the mileage maintenance screen.
- Hold the **button for 3 seconds** to clear the Trip B recordings.



NOTE Display can be switch off (refer to setting 4-8-1)

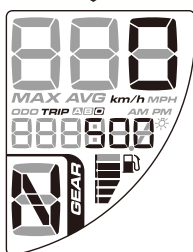

- In the mileage maintenance screen, press the **button once** to switch to the remaining mileage screen.
- Mileage maintenance will count down from setting value, when it reaches 0, the screen will blink to indicate mileage reached.



- When reminding feature is activated, it will automatically return to mileage maintenance screen if the mileage maintenance value is reached.



- Hold the **button for 3 seconds** to switch to inform function switch.



NOTE It will not display if it's not supported in engine computer.

- Hold the **button for 3 seconds** to clear the mileage maintenance recordings.

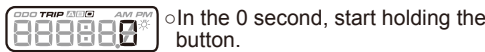

- In the 0 second, start holding the button.



- In the 3rd second, the inform feature will blink once.



- In the 5th second, inform feature will switch back, mileage display will begin blinking.



- During the 6~9th seconds, if release button, will cancel the process.



- On the 10th second, the mileage maintenance record is cleared.



NOTE Display can be switch of (refer to setting 4-9)

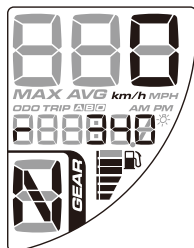

- In the remaining mileage screen, press the **button once** to switch to the average fuel consumption screen.
- Remaining mileage is lower than 16 km (10 mile), will display "LO RING" to inform users.



- When reminding feature is activated, it will automatically return to the remaining mileage screen, if remaining mileage is too low
- When reminding feature is activated, it will automatically switch to the remaining mileage screen during startup, if remaining mileage is too low.



- Hold the **button for 3 seconds** to switch to inform feature switch.



NOTE It will not display if it's not supported in engine computer.

- The following situation will result displaying "r----" or no display at all.

○ Abnormal fuel sensor (short / open circuit)

- Fuel related settings will affect this value's precision.

NOTE Display can be switch off (refer to setting 4-7-3)

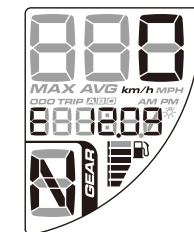

- In the average fuel consumption screen, press the **button once** to switch to the clock screen.

NOTE It will not display if it's incompatible in engine computer.

NOTE Display can be switch off (refer to setting 4-7-4)

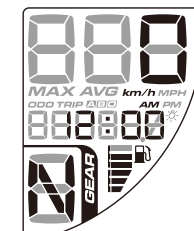

- In the clock screen, press the **button once** to switch to the engine temperature screen.

NOTE Display can be switch off (refer to setting 4-1)

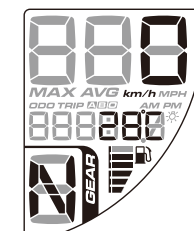

- In the engine temperature screen, press the **button once** to switch to the voltage screen.

NOTE Display can be switch off (refer to setting 4-8-2)

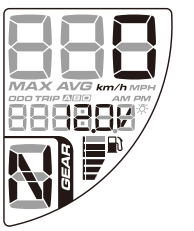

- In the voltage screen, press the **button once** to return to total mileage screen.

NOTE Display can be switch off (refer to setting 4-8-3)

4 Settings and features index screen



•When the engine switch is OFF, hold the **button for 3 seconds** to enter settings.

•Features index screen

- a 1.Time(time format, time adjustment) - refer to procedure 4-1
- a 2.Unit(speed unit, temperature unit)- refer to procedure 4-2
- a 3.Back light(back light color, brightness)- refer to procedure 4-3
- a 4.Tire(tire ratio percentage)- refer to procedure 4-4
- a 5.Gear(gear indicating mode)- refer to procedure 4-5
- a 6.Warning light(overspeed warning)-refer to procedure 4-6
- a 7.Fuel - refer to procedure 4-7
 - └ 1.Fuel sensor type 4-7-1
 - └ 2.Fuel test display 4-7-2
 - └ 3.Fuel tank volume 4-7-3
 - └ 4.Fuel consumption display 4-7-4
- a 8.Feature display- refer to procedure 4-8
 - └ 1.Mileage B display switch 4-8-1
 - └ 2.Engine temperature display switch 4-8-2
 - └ 3.Voltage display switch 4-8-3
- a 9.Mileage maintenance - refer to procedure 4-9
- a10.Total mileage-refer to procedure 4-10
 - └ 1.Unable to adjust internal mileage 4-10-1
 - └ 2.Able to adjust external mileage 4-10-2
- Exit settings

4-1 Clock settings

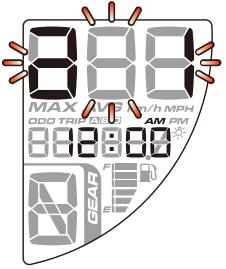

•In the clock settings screen, hold the **button for 3 seconds** to enter into the setting screen.

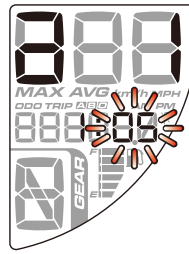

•**Example : Set time clock setting from 1:00 to 1:05.**

•Hold the **button for 3 seconds** to return to the clock settings main screen.



•EX : If want to set time to 24 hours format.
•Press the **button once** to select desired setting value.

⚠ Now the setting value will blink.

NOTE Setting range : 12 / 24 hours format.

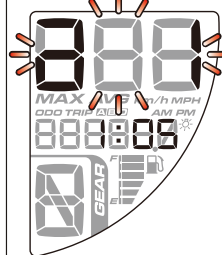

•Clock settings main screen.

•Press the **button once** to enter next setting.



•**Example : Set time settings from 12 hours format to 24 hours format.**

•Hold the **button for 3 seconds** to enter time into the (hour) setting screen.

4-2 Speed, temperature unit settings

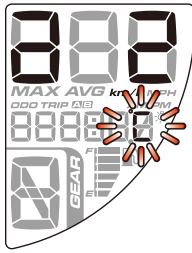

- In the speed, temperature unit settings main screen, hold the **button for 3 seconds** to enter into the main screen.

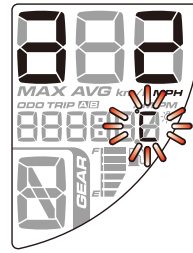

- EX : To set the temperature unit to °F.
- Press the **button once** to select the desired value.

⚠ Now the setting value will blink.

NOTE Settings range : °C(Celsius) and °F(Fahrenheit)

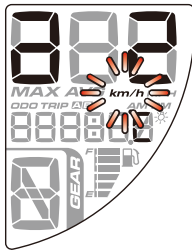

- EX : To set speed unit to MPH(mile).
- Press the **button once** to select the desired value.

⚠ Now the setting value will blink.

NOTE Settings range : km/h, km and MPH, mile.

NOTE Total mileage and distance meter unit will vary according to the speed unit.

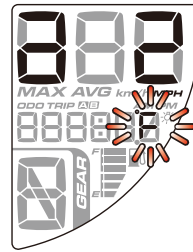

- **Example** : Set temperature unit from °C(Celsius) and °F(Fahrenheit)
- Hold the **button for 3 seconds** to return to the speed, temperature unit settings main screen.

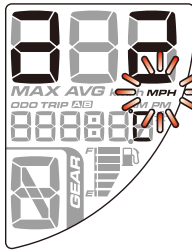

- **Example** : Set speed unit from km/h, km to MPH mile.
- Hold the **button for 3 seconds** to enter into the temperature unit settings screen.

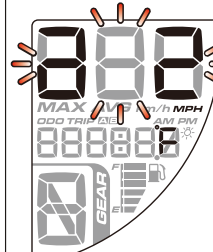

- In the temperature unit settings main screen.
- Press the **button once** to enter next setting.

4-3 Backlight brightness settings

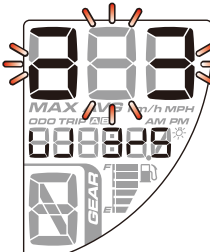

- In the backlight (color / brightness) settings main screen, hold the **button for 3 seconds** to enter into the settings screen.

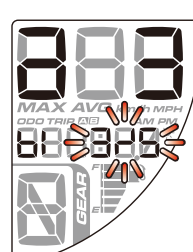

- EX : To set the backlight (brightness) to 5/5 (100%).
- Press the **button once** to select the desired value.

⚠ Now the setting value will blink.

NOTE Settings range : 1/5 (darkest) ~ 5/5 (brightest).

Settings unit :

Each stage about 20% brightness.

Back light brightness changes as soon as setting value changes.

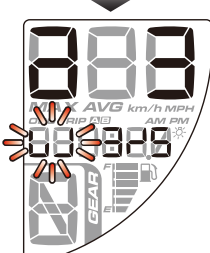

- EX : To set the backlight (color) to blue.
- Press the **button once** to select the desired value.

⚠ Now the setting value will blink.

NOTE Settings range : Red (rE), Orange light (Or), Yellow (YE), Green (Gr), Blue (bl), Indigo (In), Purple (Pu), White (W).

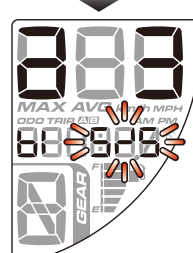

- **Example** : Set the backlight (brightness) from 3/5 (60%) to 5/5 (100%).
- Hold the **button for 3 seconds** to return to the backlight (Color / Brightness) settings main screen.

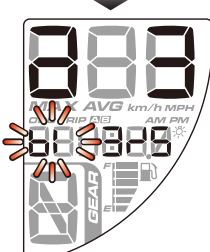

- EX : Changing backlight color from white (w) to blue(bl).
- Hold the **button for 3 seconds** to enter into the backlight (brightness) settings screen.

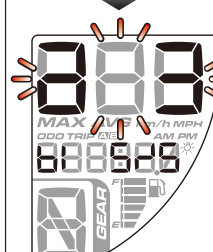

- Backlight (color / brightness) settings main screen.
- Press the **button once** to enter next setting.

4-4 The tire circumference settings

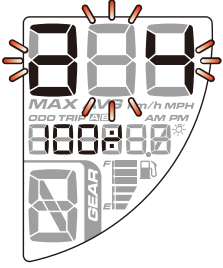

- In the tire circumference setting, hold the **button** for **3 seconds** to enter into the setting screen.

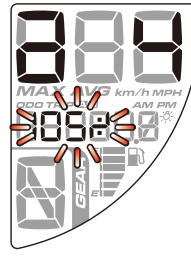

- **Example** : Set tire percentage from **100%** to **105%**.
- Hold the **button** for **3 seconds** to return to the tire circumference main screen.

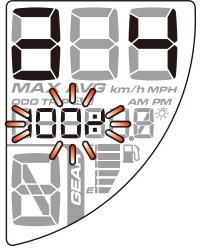

- Hold the **button** for **3 seconds** to move the cursor to the desired settings level.



⚠ Now the setting value will blink.

- Hold the **button** for **3 seconds** select the desired value.

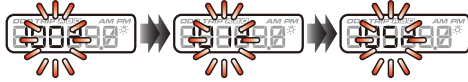

NOTE Setting range : 50 ~ 210%.

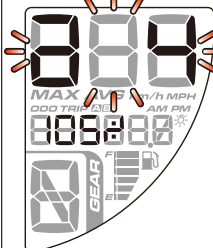

- Tire percentage settings main screen.
- Press the **button** **once** to enter next setting.

4-5 Gear display settings

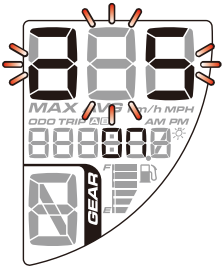

- In the gear settings screen, hold the **button** for **3 seconds** to enter into the setting screen.

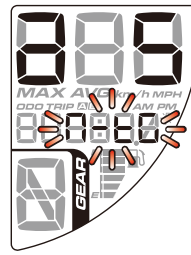

- **Example** : Set gear from **On** (show all N / 1 ~6) to **n-tG** (N and highest gear).
- Hold the **button** for **3 seconds** to return to the gear settings main screen.

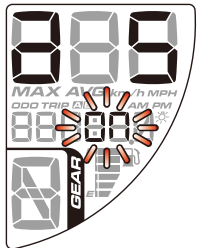

- **EX** : To set gear as n-tG (N and highest gear).
- Press the **button** **once** to select the desired value.

⚠ Now the setting value will blink.

NOTE Settings range : On (show all N / 1 ~6), OFF tG (highest gear), n-tG (N and highest gear).

- NOTE**
- Highest gear is learned during traveling.
 - To relearn the gear level, detach the meter's main power for 30 seconds then reconnect it again.

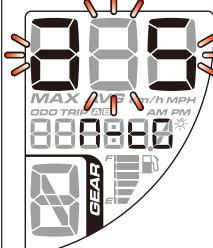

- In the gear settings main screen.
- Press the **button** **once** to enter next setting.

4-6 The RPM shift light warning settings



- In the RPM shift light warning settings main screen, hold the **button for 3 seconds** to enter into the main screen.



- Hold the **button for 3 seconds** to move the cursor to the desired settings level.



⚠ Now the setting value will blink.

- Hold the **button** to select desired value.



NOTE Setting range : 2,000 ~ 8,000



- **Example : Set RPM shift light warning from 5,500 r to 5,700 r.**
- Hold the **button for 3 seconds** to enter into the Max. RPM warning mode screen.



- EX : To set the Max. RPM warning mode to F-ON (blink).
 - Press the **button once** to select the desired value.
- ⚠ Now the setting value will blink.

NOTE Settings range : F-OFF (Lid.), F-ON (blink).



- **Example : Set Max. RPM warning mode from F-OFF (Lit) to F-ON (blink).**
- Hold the **button for 3 seconds** to return to the overspeed warning settings screen.



- Overspeed settings main screen.
- Press the **button once** to enter next setting.

4-7 Fuel settings

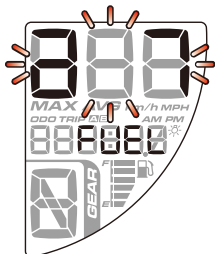

- In the fuel settings main screen, hold the **button for 3 seconds** to enter into the sub settings screen.

4-7-1

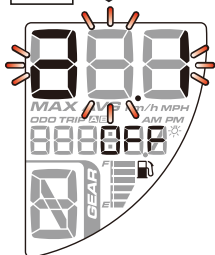

- In the fuel type screen, hold the **button for 3 seconds** settings screen.

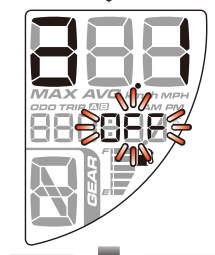

- EX : To set the fuel type to CUS_t (user define).
 - Press the **button once** to select the desired value.
- ⚠ Now the setting value will blink.

NOTE Settings range :
 1.OFF (Fuel display,off)
 2.dYNA (Dyna)
 3.CUS_t (User define)

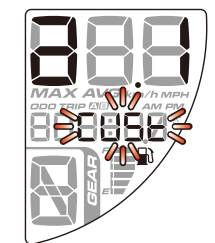

- **Example : Set fuel type from OFF (off) to CUS_t (user define).**
- Hold the **button for 3 seconds** to enter into the user define mode.

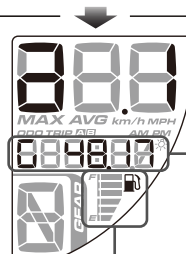

- User define mode : Needs to learn the position of 0% (E), 33%, 66%, 100% (F) fuel volume.

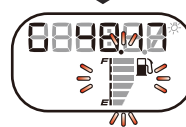
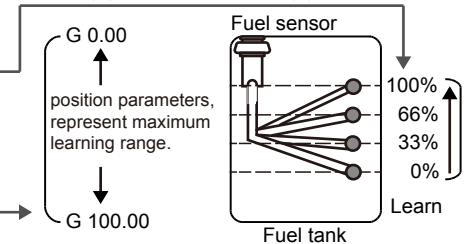

- Fuel volume 0% position learning screen.
- Confirm that there it is low fuel before learning.
- Allow the vehicle to be still for 10 ~ 15 seconds in order to steady the liquid surface.
- Press the **button once** to learn the current fuel position.
- Hold the **button for 3 seconds** to enter into the next fuel volume position learning screen.

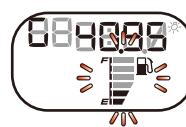

- Fuel volume 33% position learning screen.
- Confirm that there is 1/3 fuel volume in fuel tank before learning.
- Allow the vehicle to be still for 10 ~ 15 seconds in order to steady the liquid surface.
- Press the **button once** to learn current fuel position.
- Hold the **button for 3 seconds** to enter into the next fuel volume position learning screen.

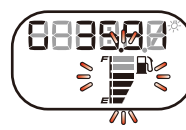

- Fuel volume 66% position learning screen.
- Confirm that there is 1/3 fuel volume in fuel tank before learning.
- Allow the vehicle to be still for 10 ~ 15 seconds in order to steady the liquid surface.
- Press the **button once** to learn current fuel position.
- Hold the **button for 3 seconds** to enter into the next fuel volume position learning screen.

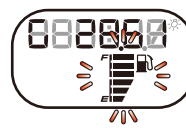

- Fuel volume 100% position learning screen.
- Confirm that there is 1/3 fuel volume in fuel tank before learning.
- Allow the vehicle to be still for 10 ~ 15 seconds in order to steady the liquid surface.
- Press the **button once** to learn current fuel position.
- Hold the **button for 3 seconds** to enter into the next fuel volume position learning screen.

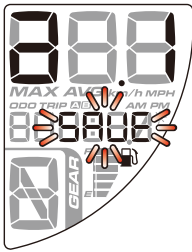

- Learning conformation screen.
- Hold the **button once** to save the current learning results, then automatically return to fuel type settings screen.



- If an error occurs in the learning process, it will display "error" when saving. Then abandon this learning and return to fuel type screen.



- Hold the **button for 3 seconds** to renounce current learning result and return to the sub settings screen.

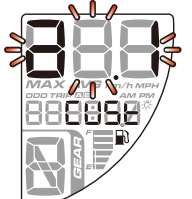

- In the Fuel type settings screen.
- Press the **button once** to enter the next setting.

- NOTE** Setting range:
- When set to OFF, will return to fuel type settings screen.
 - When set to other settings, will enter next setting option.

4-7-2

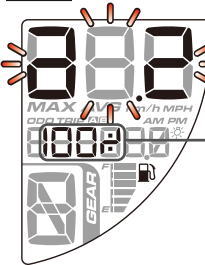

- Fuel position indicator.
- This screen will display the current liquid surface position, if it exceeds the range it is recommended to reset the fuel volume parameters to acquire more precise fuel volume and range information.

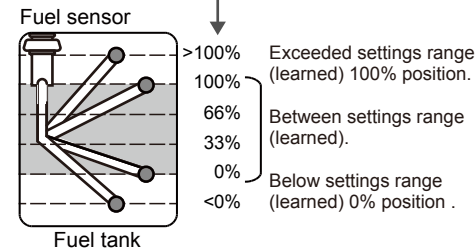

- Press the button to enter fuel volume settings.

4-7-3

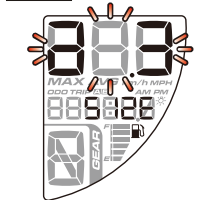

- In fuel tank volume settings screen, hold the **button for 3 seconds** to enter into the settings screen.

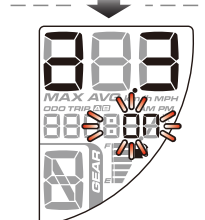

- EX : To set fuel volume as ON.
- Hold **button once** to select desired setting value.

⚠ Now the setting value will blink.

NOTE Setting range : ON, OFF



- **Example** : Set fuel volume from OFF to ON.
- Hold the **button for 3 seconds** to return to enter the fuel volume settings screen.

NOTE When set to OFF, will return to sub setting screen.

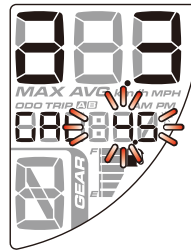

- Hold the **button for 3 seconds** to move the cursor to the desired settings level.



⚠ Now the setting value will blink.

- Hold **button once** to select desired setting value.



NOTE Setting range : 1.0 ~ 9.9 US gallons

NOTE Volume calculation method checks for the total volume of the fuel tank and low fuel indicating volume in the user manual of vehicle, then substitutes it into the equation below :
total vol. - (low fuel vol. / 2) = setting value.
Then enter the result into the setting value.

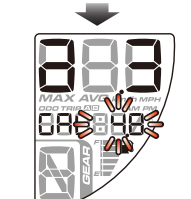

- **Example** : Set fuel volume value from 4.5 to 4.8.
- Hold the **button for 3 seconds** to return to fuel volume settings screen.

4-7-4

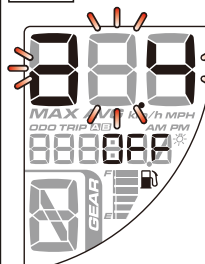

- To enter sub-settings screen, hold the **button for 3 seconds** to enter fuel consumption settings screen.

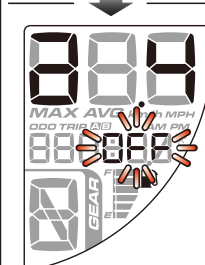

- EX : To set fuel consumption unit as MPG (US).
- Hold **button once** to select desired setting value.

⚠ Now the setting value will blink.

NOTE Setting range : OFF, L/100 km, km/L, MPG (US), MPG (UK).

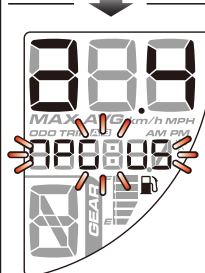

- **Example** : Set fuel consumption unit from OFF to MPG (US).
- Hold the **button for 3 seconds** to return to the fuel consumption unit (a.4) settings screen.

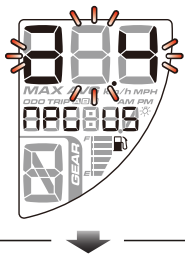

- In the fuel consumption unit (a.4) settings screen.
- Press the **button once** to return to the features display settings screen.

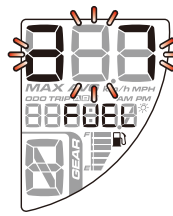

- In the features display settings main screen.
- Press the **button once** to enter next setting.

4-8 Features display settings

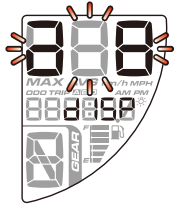

- In the display settings main screen, hold the **button for 3 seconds** to enter into the sub settings screen.

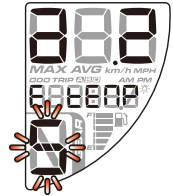

- EX : To hide (H) the engine temperature display.
 - Press the **button once** to select the desired value.
- ⚠ Now the setting value will blink.
- NOTE** Settings range : Hidden (H), Show (S).

4-8-1

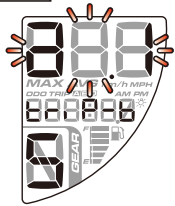

- In Trip B display settings main screen, hold the **button for 3 seconds** to enter into the settings screen.

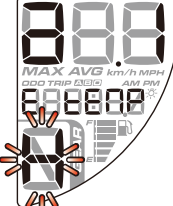

- Engine temperature display settings main screen.
- Press the **button once** to enter into the voltage display settings main screen.

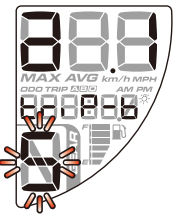

- EX : To hide (H) trip B display.
 - Press the **button once** to select the desired value.
- ⚠ Now the setting value will blink.
- NOTE** Settings range : Hidden (H), Show (S).



- Engine temperature display settings main screen.
- Press the **button once** to enter into the voltage display settings main screen.

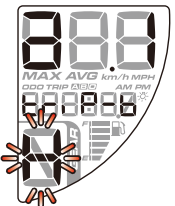

- Example : Set type B display from show (S) to hidden (H).
- Hold the **button for 3 seconds** to return to trip B display setting main screen.

4-8-3

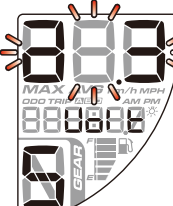

- In the voltage display settings main screen, hold the **button for 3 seconds** to enter into the settings screen.

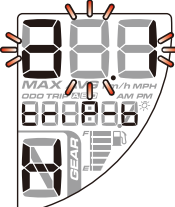

- Trip B display settings main screen.
- Press the **button once** to enter into the engine temperature display settings main screen.

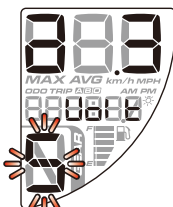

- EX : To hide (H) voltage display.
 - Press the **button once** to select the desired value.
- ⚠ Now the setting value will blink.
- NOTE** Settings range : Hidden (H), Show (S).

4-8-2

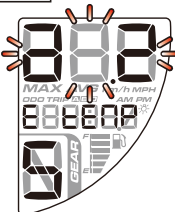

- In the engine temperature display settings main screen, hold the **button for 3 seconds** to enter into the settings screen.

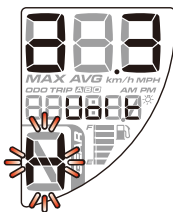

- Example : Set voltage display from show (S) to hidden (H).
- Hold the **button for 3 seconds** to return to the voltage display settings main screen.

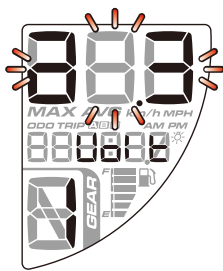

- Voltage display settings main screen.
- Press the **button once** to enter into the feature display settings main screen.

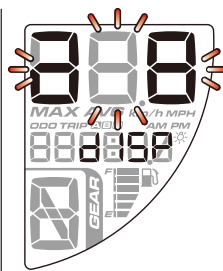

- In the features display settings main screen.
- Press the **button once** to enter next setting.

4-9 Total internal and external mileage settings

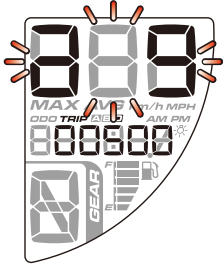

- In the total mileage settings main screen, hold the **button for 3 seconds** to enter into the sub settings screen.

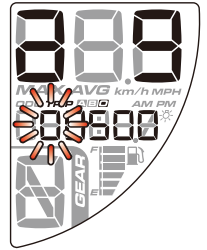

- Hold the **button for 3 seconds** to move the cursor to the desired settings level.



⚠ Now the setting value will blink.

- Hold **button once** to select desired setting value.



NOTE Setting range :
500 ~ 16,000 km (300 ~ 10,000 mile)

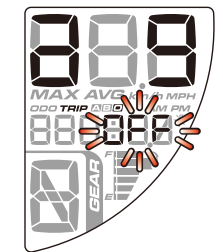

- EX : To set mileage maintenance to (ON).
- Press the **button once** to select the desired settings value.

⚠ Now the setting value will blink.

NOTE Display range : ON, OFF.



- **Example : Set the mileage maintenance from 500 to 800.**
- Hold the **button for 3 seconds** to return to mileage maintenance main screen.

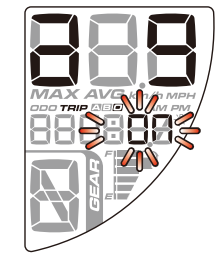

- **Example : Set mileage maintenance from OFF to ON.**
- Hold the **button for 3 seconds** to enter into the mileage maintenance main screen.

NOTE When is set to OFF, will directly return to mileage maintenance main screen.

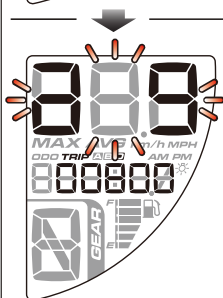

- Mileage maintenance settings main screen.
- Press the **button once** to enter into the next settings screen.

4-10 Total internal and external mileage settings

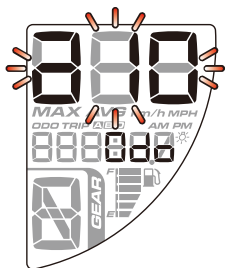

- In the total mileage settings main screen, hold the **button for 3 seconds** to enter into the sub settings screen.



- Hold the **button for 3 seconds** to move the cursor to the desired settings level.



⚠ Now the setting value will blink.

- Hold **button once** to select desired setting value.



NOTE Setting range : 0 ~ 999,999 km (mile).

4-10-1

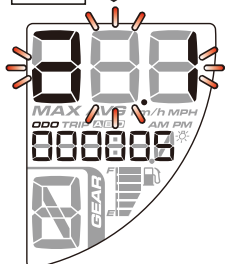

- EX : Current total internal mileage display is 5 km.
- Press the **button once** to enter into the total external mileage settings screen.
- ⚠ User unable to adjust or remove total internal mileage.

NOTE Display range : 0 ~ 999,999 km (mile).

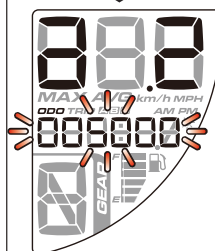

- **Example : Set the total external mileage from 1,000 to 5,000 km.**
- Hold the **button for 3 seconds** to move the cursor to the desired setting level.

4-10-2

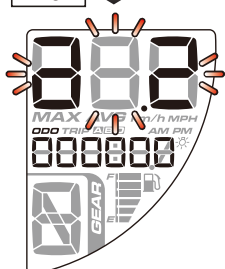

- In the total external mileage settings main screen, hold the **button for 3 seconds** to enter into the settings screen.

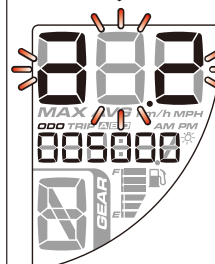

- Total external mileage settings main screen.
- Press the **button once** to return to total mileage settings main screen.

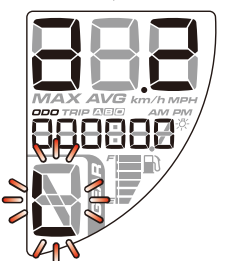

- **Example : To import the original bike mileage from ECU to the meter.**
- Short press the button once to import the original bike mileage from ECU to the meter.



NOTE If the tired ratio setting was adjusted. The meter mileage will NOT be synchronized with the original bike mileage from the ECU.

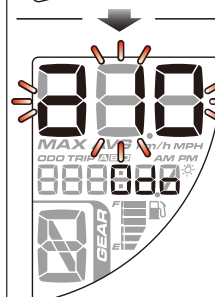

- Total mileage settings main screen.
- Press the **button once** to return to startup screen.

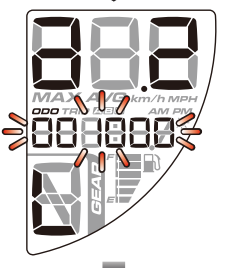

- **Example : External mileage is imported from ECU.**
- Hold the **button for 3 seconds** to enter external mileage setting menu.

5 Trouble shooting

The following situation does not indicate malfunction of the meter. Please check the following points, before taking it in for repairs.

Trouble	Check item
The meter doesn't work when the power is on.	<ul style="list-style-type: none"> • The power doesn't supply to the meter. <ul style="list-style-type: none"> → Please make sure the wiring is connected. The wiring and fuse are not broken. → The battery is broken or the battery is too old to supply enough power DC 12V to make the meter work.

※ If the problems persist after viewing the steps above, please contact your local distributor.