

Instruction 510-0727

12-19-19

© 2019

by S&S® Cycle, Inc.

All rights reserved.
Printed in the U.S.A.

S&S® Cycle, Inc.

14025 Cty Hwy G

Viola, Wisconsin 54664

Phone: 608-627-1497

Technical Service Email: sstech@sscycycle.com

Website: www.sscycycle.com



Installation Instructions: S&S Three Piece Flywheel Assemblies for 2017–up Harley-Davidson® Milwaukee Eight® Engines

DISCLAIMER:

S&S parts are designed for high performance, closed course, racing applications and are intended for the very experienced rider only. The installation of S&S parts may void or adversely affect your factory warranty. In addition such installation and use may violate certain federal, state, and local laws, rules and ordinances as well as other laws when used on motor vehicles used on public highways, especially in states where pollution laws may apply. Always check federal, state, and local laws before modifying your motorcycle. It is the sole and exclusive responsibility of the user to determine the suitability of the product for his or her use, and the user shall assume all legal, personal injury risk and liability and all other obligations, duties, and risks associated therewith.

The words Harley®, Harley-Davidson®, H-D®, Sportster®, Evolution®, and all H-D part numbers and model designations are used in reference only. S&S Cycle is not associated with Harley-Davidson, Inc.

SAFE INSTALLATION AND OPERATION RULES:

Before installing your new S&S part it is your responsibility to read and follow the installation and maintenance procedures in these instructions and follow the basic rules below for your personal safety.

- Gasoline is extremely flammable and explosive under certain conditions and toxic when breathed. Do not smoke. Perform installation in a well ventilated area away from open flames or sparks.
- If motorcycle has been running, wait until engine and exhaust pipes have cooled down to avoid getting burned before performing any installation steps.
- Before performing any installation steps disconnect battery to eliminate potential sparks and inadvertent engagement of starter while working on electrical components.
- Read instructions thoroughly and carefully so all procedures are completely understood before performing any installation steps. Contact S&S with any questions you may have if any steps are unclear or any abnormalities occur during installation or operation of motorcycle with a S&S part on it.
- Consult an appropriate service manual for your motorcycle for correct disassembly and reassembly procedures for any parts that need to be removed to facilitate installation.
- Use good judgment when performing installation and operating motorcycle. Good judgment begins with a clear head. Don't let alcohol, drugs or fatigue impair your judgment. Start installation when you are fresh.
- Be sure all federal, state and local laws are obeyed with the installation.
- For optimum performance and safety and to minimize potential damage to carb or other components, use all mounting hardware that is provided and follow all installation instructions.
- Motorcycle exhaust fumes are toxic and poisonous and must not be breathed. Run motorcycle in a well ventilated area where fumes can dissipate.

IMPORTANT NOTICE:

Statements in this instruction sheet preceded by the following words are of special significance.



WARNING

Means there is the possibility of injury to yourself or others.

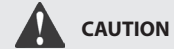

CAUTION

Means there is the possibility of damage to the part or motorcycle.

NOTE

Other information of particular importance has been placed in italic type.

S&S recommends you take special notice of these items.

WARRANTY:

All S&S parts are guaranteed to the original purchaser to be free of manufacturing defects in materials and workmanship for a period of twelve (12) months from the date of purchase. Merchandise that fails to conform to these conditions will be repaired or replaced at S&S's option if the parts are returned to us by the purchaser within the 12 month warranty period or within 10 days thereafter.

In the event warranty service is required, the original purchaser must call or write S&S immediately with the problem. Some problems can be rectified by a telephone call and need no further course of action.

A part that is suspect of being defective must not be replaced by a Dealer without prior authorization from S&S. If it is deemed necessary for S&S to make an evaluation to determine whether the part was defective, a return authorization number must be obtained from S&S. The parts must be packaged properly so as to not cause further damage and be returned prepaid to S&S with a copy of the original invoice of purchase and a detailed letter outlining the nature of the problem, how the part was used and the circumstances at the time of failure. If after an evaluation has been made by S&S and the part was found to be defective, repair, replacement or refund will be granted.

ADDITIONAL WARRANTY PROVISIONS:

- (1) S&S shall have no obligation in the event an S&S part is modified by any other person or organization.
- (2) S&S shall have no obligation if an S&S part becomes defective in whole or in part as a result of improper installation, improper maintenance, improper use, abnormal operation, or any other misuse or mistreatment of the S&S part.
- (3) S&S shall not be liable for any consequential or incidental damages resulting from the failure of an S&S part, the breach of any warranties, the failure to deliver, delay in delivery, delivery in non-conforming condition, or for any other breach of contract or duty between S&S and a customer.
- (4) S&S parts are designed exclusively for use in Harley-Davidson® and other American v-twin motorcycles. S&S shall have no warranty or liability obligation if an S&S part is used in any other application.

SPECIAL TOOL REQUIREMENTS

- Harley-Davidson® service manual or S&S® service manual for the specific model or engine you are working on
- Timken® bearing install tool—for engines with Timken sprocket shaft bearings
- Feeler gauge
- Dial indicator
- Torque wrench

GENERAL INFORMATION

- Thoroughly read and understand the section that pertains to the flywheels you are installing.
- If you don't have the required tools or knowledge for installing these flywheels you should have a qualified shop install them.
- It is the engine builder's responsibility to confirm proper clearances when assembling an engine.
- S&S produces M8 flywheel assemblies with connecting rods of two different lengths. Connecting rods are available with either tapered or straight wristpin ends. Make sure the connecting rods are correct for your application: **(See Picture 1)**

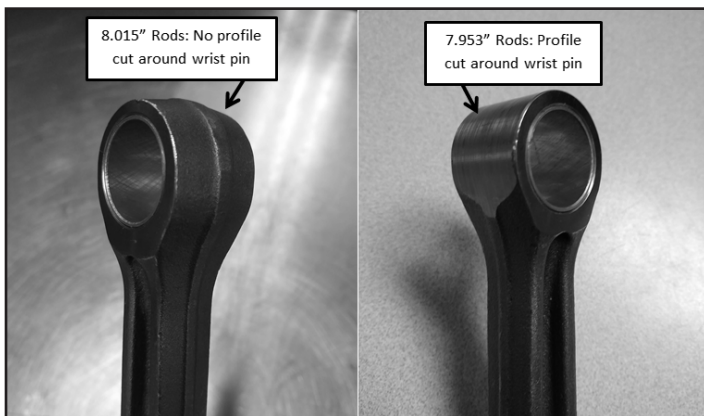

Picture 1

- 2017–up M8 Models, 8.015" length rod for 4³/₈" and 4¹/₂" stock stroke flywheels
- 2017–up M8 Models, 7.953" length rod for 4⁵/₈" flywheels.
- M8 engines contain either one (touring models) or two (Softail® models) balancers. Balancer(s) must be timed correctly to prevent contact with connecting rods.

S&S produces M8 flywheel assemblies with and without balancer drive gears. Flywheels without gears must not be assembled with balancers. Flywheels with gears may be assembled with both single and dual balanced M8 engines, or with no balancer at all.

DISASSEMBLY

Refer to the Harley-Davidson service manual or S&S service manual for the specific model or engine you are working on for the correct disassembly procedure.

The engine will need to be removed from the frame of the motorcycle and completely disassembled.

INSTALLATION

Preparation for Installation

Remove flywheel assembly from packaging material. Handle with care to avoid dropping and potentially cutting your hands on sharp edges. Using a lint free cloth and lacquer thinner, thoroughly clean flywheel assembly to remove rust preventative oil.

Do not immerse or wash the flywheel in a solvent tank. Connecting rod bearings are coated in grease which may become contaminated by dirt and debris if put in a solvent tank.

If flywheel is checked for runout, measurements should be checked at the bearing surfaces while fixtured on the mainshaft centers in a truing stand. The total indicated runout (TIR) for new S&S flywheels should be less than .0005".

Inspect flywheel assembly to make sure you have the correct style, diameter, stroke, and mainshafts are correct for your application. See identification chart below.

Stroke Codes	
Code	Stroke
–	3.600"
21	3 7/8"
17	4"
19	4 1/8"
9	4 3/16"
5	4 1/4"
1	4 3/8"
2	4 1/2"
6	4 5/8"
3	4 3/4"
7	4 13/16"
4	5"
Engine Style	
Code	Engine Style
SF3	1999–up bt 2017–up M8
Flywheel Diameter	
Code	Diameter
X	8 3/8"

Flywheel Installation

1. Replace the pinion shaft bearing in the right side crankcase with a new bearing. Follow factory procedures.
2. Check flywheel and connecting rod to crankcase clearances. This is of particular importance with longer than stock strokes.
 - a. Install flywheel assembly in left crankcase only.
 - b. Assemble pistons without rings on their proper connecting rods. Installation of wristpin clips is not necessary.

NOTE: Rear piston has piston to piston clearance notch machined in piston skirt, place notch toward center of engine.

- c. Install both cylinders and temporarily secure each cylinder with one nut.
- d. Rotate flywheel to positions where connecting rods are closest to crankcase and cylinder spigots in front and rear. There must be a minimum of .060" clearance between connecting rods and crankcases or cylinder spigots. **See Picture 2, below.**



Picture 2

- e. Clearance crankcases or cylinder spigots if needed by grinding or machining material from areas of contact or insufficient clearance. Connecting rod to crankcase clearance is usually not a problem with S&S Stroker kits, but if engines are built with longer strokes or heavier connecting rods a potential for contact exists.
- f. If the right crankcase half requires clearancing, the left crankcase half will also require clearancing. Clearance as needed.

NOTE: If clearancing is required, tape off the bearings to prevent chips from getting into bearings.

- g. Disassemble cylinders and pistons. Remove flywheel assembly from right crankcase.
3. Clean all lower end parts for final assembly.
4. Thoroughly clean crankcase mating surfaces with solvent and a shop-quality scrubbing pad to remove any residual gasket material from the sealing surfaces.
5. Wash the cases in warm soapy water, rinse and blow dry. Wipe them one last time with a clean, dry cloth.

NOTE: Cleaning parts prior to and during assembly and keeping parts clean after final assembly are imperative to minimize contaminants that may circulate in oil and shorten engine life. Many parts can be cleaned with soap and water first. Then, reclean all internal parts and gasket mating surfaces using high quality solvent that does not leave any harmful residues.

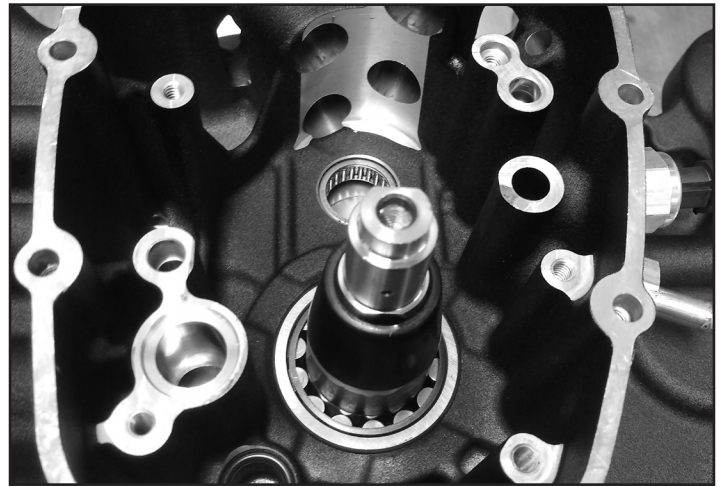

Picture 3

6. In order to assemble the right side case half S&S recommends the use of a pinion shaft guide (Jims® #1288 or similar). The guide fits over the pinion shaft **as shown in Picture 3, above.** The shaft guide positions the rollers in the right crankcase bearing so the shaft can slip through as the right case is lowered into place.
7. Place the case/flywheel on a flat surface with the camchest down. The flywheel will be pushed out of the case slightly (the bearing race will not be completely removed from the bearing roller), allowing the balancer(s) to be installed.
8. Balancers must be timed with the flywheel gear by aligning the 0 or I mark in the valley of the balancer gear and the 0 or I mark in the peak of the flywheel gear. The like marks must be aligned. Do not the align an I mark with a 0 mark. **See Picture 4 below.**

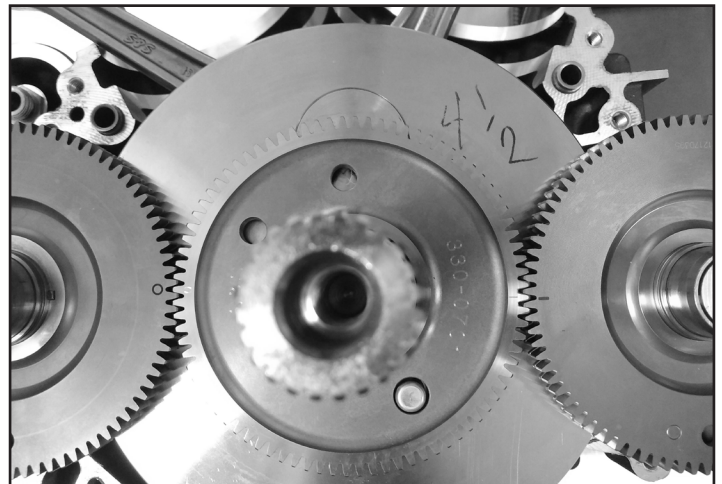

Picture 4 (Dual Balancer Shown)

- Rotate the flywheel to TDC. Place a punch or similar tool in the alignment holes of the balancer anti-backlash gear. Press the top of the punch clockwise **as shown in Picture 5**.

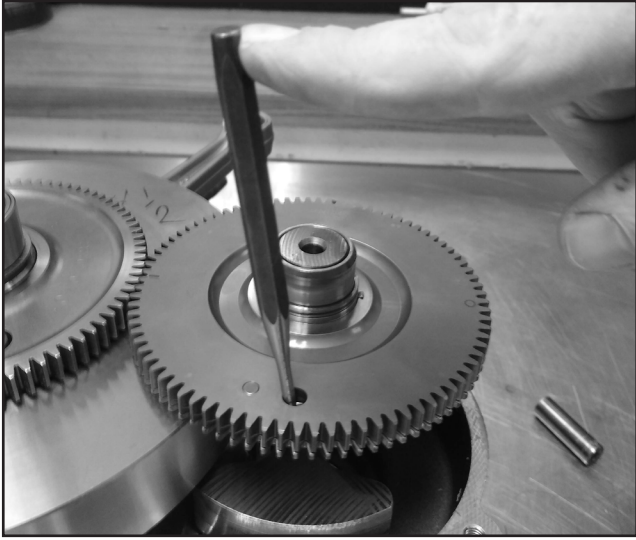

Picture 5

- Install the balancer in the right side case, maintaining the pressure on the punch and aligning the timing marks. Remove the punch. A properly installed balancer will have no play with the flywheel, and the alignment holes will be centered, **as shown in Picture 6**.

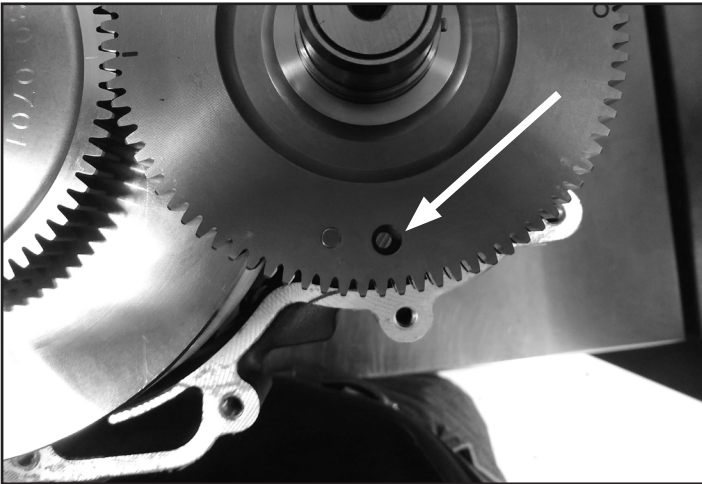

Picture 6

- Place the right side case, flywheel, and balancer(s) on a stand allowing the flywheel and balancers to fully seat in the case. A coffee can or small bucket works well for this. Verify the balancer is still timed correctly.
- Allow sealant to cure per the manufacturer's instructions and install the right crankcase half. S&S® uses and recommends Threebond® 1184 to seal the joint between left and right crankcases. Apply a consistent thin coat to both cases, taking care not to get any material in a place where it could get inside the engine. Take special care not to block oil return passages.

- Install the case bolts and tighten the 5/16" fasteners to 18 ft-lbs. be tightened to 120 in-lbs. **See Picture 7** for single balanced engine torque sequence. **See Picture 8** for dual balanced engine torque sequence.

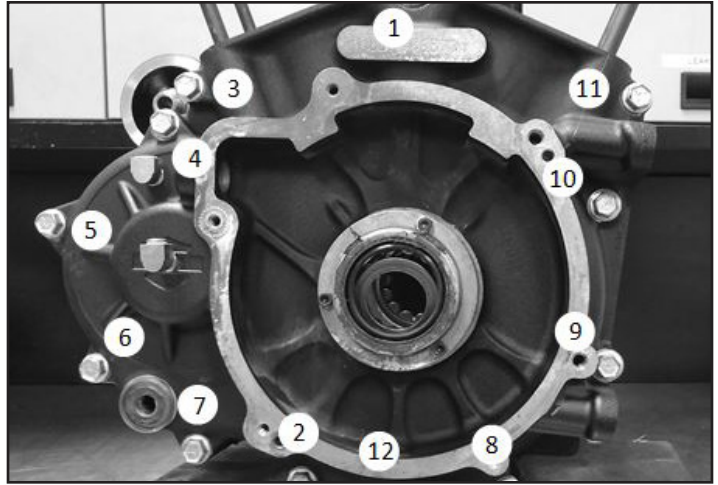

Picture 7

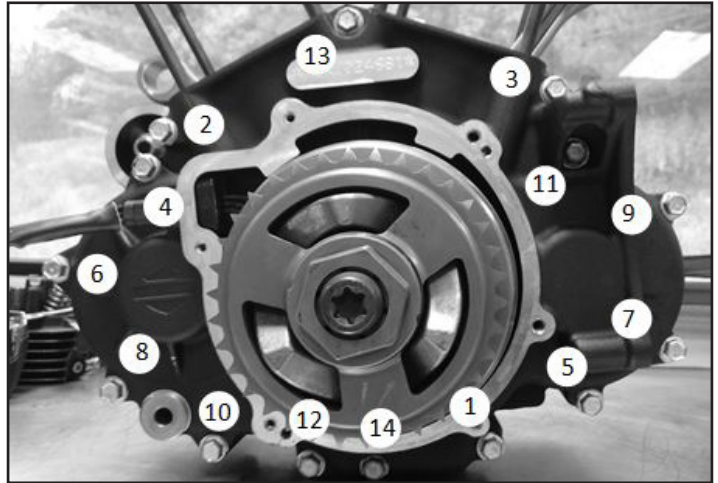

Picture 8

- Install the compensator per the manufacturer's instructions
- Mount a dial indicator on the right side of the lower end assembly. Put the indicator on the pinion shaft so it measures in and out horizontal shaft movement. **See Picture 9**.

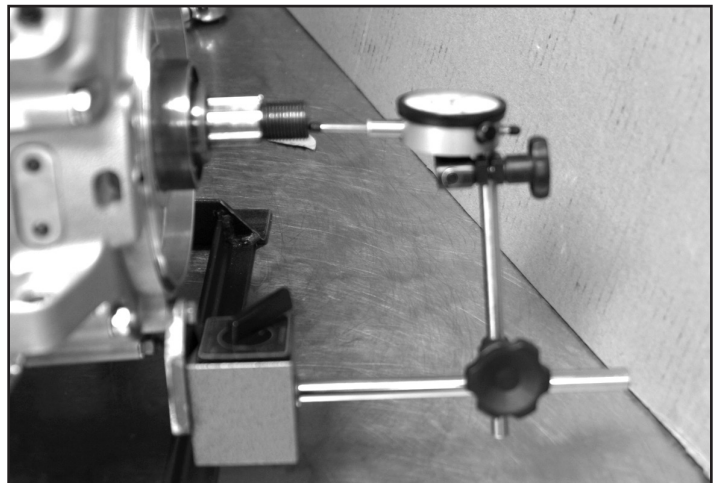

Picture 9

16. Rotate the shaft and push in on it, noting the indicator reading. Rotate the shaft and pull on it, noting the dial indicator reading. The difference between the two readings is the endplay—it should be between .003" and .013".
17. If endplay is not within this range, the main bearing spacer must be changed. Remember a thinner spacer will produce less endplay.
18. Rotate the flywheel to verify there is no interference between the flywheel and other components.
19. With the flywheel assembly installed in the crankcases, the rest of the engine may be assembled. Follow steps outlined in stock or S&S service manual. In addition, follow any special steps required for any aftermarket or high performance components used in the engine.

CLEARANCE SPECIFICATIONS		
S&S® THREE PIECE FLYWHEEL ASSEMBLY		
COMPONENT	FACTORY SPECIFICATION	SERVICE WEAR LIMIT
CONNECTING ROD SIDEPLAY	.005"-.024"	.040"
WRISTPIN CLEARANCE	.0007"-.0013"	.002"
PINION SHAFT RUNOUT*	.003" MAX	—
<i>*w/o compensator or charging system installed</i>		

Replacement Parts:

- | | | | |
|---|----------|--|----------|
| 1. Gear, Balancer Drive, 2017-up M8 Models | 330-0701 | 8. Flywheel, Partial Assembled, Right..... | N/A |
| 2. Plug, Drive, .8992" x .950", Steel, Fatigue Proof..... | 106-4991 | 9. Flywheel, Partial Assembled, Left..... | N/A |
| 3. Washer, Flywheel, Thrust, 1.780" x 2.812" x .030",
Bronze, 2017-up M8 Models..... | 320-0597 | 10. Race, Inr, L Main Brg, Mach, 1.25"x1.65"x0.713..... | 330-0154 |
| 4. Crankpin, Press-In, Straight, Standard, 1.772",
2017-up M8 Models..... | 340-0200 | 11. Washer,FW,Thrust,1.25" x 1.83" x .136"..... | 320-0034 |
| 5. Bearing, Assembly, Connecting Rod, Roller,
1.772" CP, 3 Piece, Standard, 2017-up M8 Models..... | 340-0201 | 12. Bushing, Wristpin, .928", Bronze | 340-0024 |
| 6. Connecting Rod, Front, Tapered Wristpin, 8.015" | 340-0197 | 13. Race, Inr, R Main Brg, 1.25"x1.65"x0.872" | 330-0700 |
| Connecting Rod, Front, Full Width Wristpin, 8.015" | 340-0206 | 14. Retaining Ring, External, Pinion Bearing,
1.160" x 1.480" x .046", Carbon Steel, SAE 1060-1090..... | 50-8057 |
| Connecting Rod, Front, Tapered Wristpin, 7.953" ,..... | 340-0207 | | |
| Connecting Rod, Front, Full Width Wristpin, 7.953" | 340-0208 | | |
| 7. Connecting Rod, Rear, Tapered Wristpin, 8.015" | 340-0198 | | |
| Connecting Rod, Rear, Full Width Wristpin, 8.015" | 340-0210 | | |
| Connecting Rod, Rear, Tapered Wristpin, 7.953" | 340-0211 | | |
| Connecting Rod, Rear, Full Width Wristpin, 7.953" , | 340-0212 | | |

