



Dyna Big Radius Exhaust System

Part #26007

Congratulations, you have purchased the finest exhaust system available for your motorcycle. Your VANCE & HINES exhaust system is designed and crafted for maximum performance, a perfect fit, a great sound and unbeatable style! Please follow the installation instructions below and if you have any questions, feel free to call our technical help line (562) 926-5291.

Attention Installer: (if other than owner): Please forward this instruction sheet to the purchaser of this product. These instructions contain valuable information necessary to the end user.



STOCK EXHAUST SYSTEM REMOVAL

1. Loosen heat shield clamps on both the front and rear head pipes.
2. If equipped, loosen crossover pipe clamp, located between front and rear head pipes.
3. Remove two cylinder exhaust port flange nuts from each head pipe, located at the cylinder head.
4. Remove both front and rear head pipe clamp bolts.

Tools required for installation:

Wrenches - 9/16" and 1/2"
Ratchet, 3/8" drive and 9" extension
Sockets - 9/16", 1/2" and 7/16"
Allen wrenches - 1/4" and 3/16"
5/16" nutdriver/flat blade screwdriver

5. Remove the bolts that attach mufflers to the frame.
6. Remove the complete exhaust system and set aside. Assistance may be required.
7. Remove rear head pipe clamp bracket from transmission cover. Save the bolts, one will be reused.
8. Remove bolt below left side of the transmission cover. Position mounting bracket 365-P over mounting location to determine which bolt to remove (Figure 1).
9. Carefully remove the flanges and circlips from the stock exhaust system using snapping pliers (save for re-use).
NOTE: If circlips look bent or twisted replace them with new circlips.

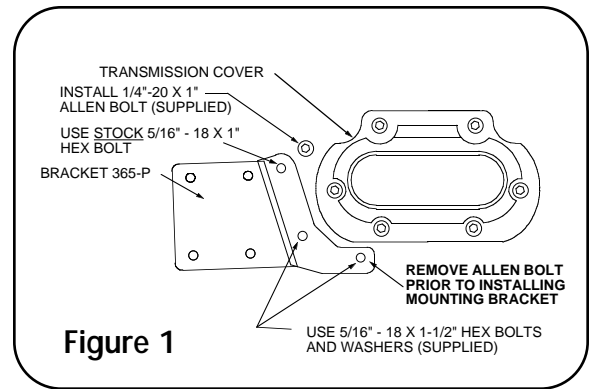

VANCE & HINES EXHAUST SYSTEM INSTALLATION

1. Check condition of stock exhaust gaskets. Replace if worn. Vance & Hines recommends you replace your gaskets with Screamin' Eagle gaskets, part number 17048-98.
2. Attach mounting bracket 365-P (supplied) to transmission using stock bolt in top hole. Install two 5/16" x 1-1/2" hex bolts and 5/16" flat washer combinations (supplied) into remaining two holes (Figure 1).
3. Replace stock mount bolt with 1/4"-20 x 1" Allen head bolt (supplied) (Figure 1).
4. On models equipped with standard foot controls, it may be necessary to space the right footpeg out to provide clearance of the front exhaust pipe. If additional clearance is required, remove footpeg and install two 3/8" x 1" spacers (supplied) between footpeg and frame. Replace stock mounting bolts and torque to 38 lbs. ft.

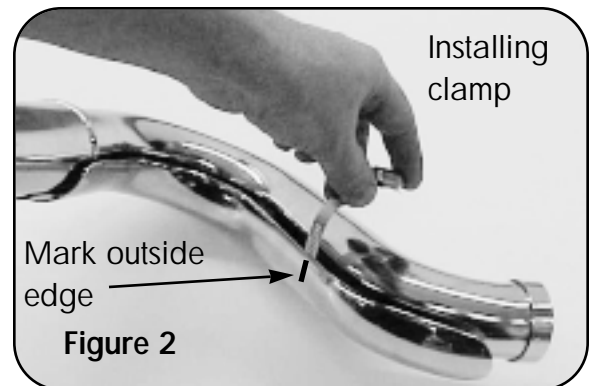

5. Remove head pipes and heat shields from protective packaging. Place each heat shield on a non-abrasive surface such as a blanket or carpet. Using a felt tip pen, mark outside edge of each heat shield to show location of hose clamp mounting clips (Figure 2).

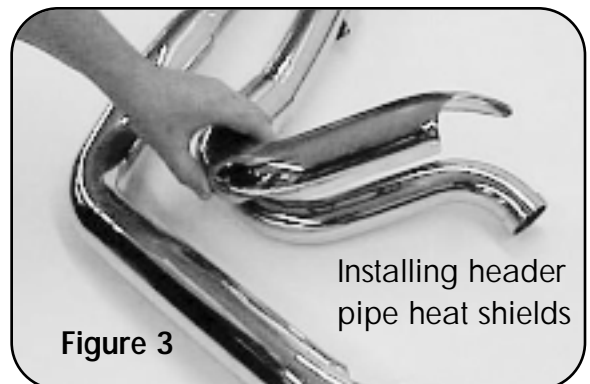

6. Lay heat shields (part # D340HC and D341HC) onto headers (Figure 3) and loosely install the #20 hose clamps into mounting clips. (**NOTE:** Muffler heat shields will be installed after pipes are on the motorcycle.) Take note of screw head direction (Figure 4). Screw heads should be accessible when system is installed on motorcycle for adjustment purposes. **NOTE:** Do not tighten at this time.

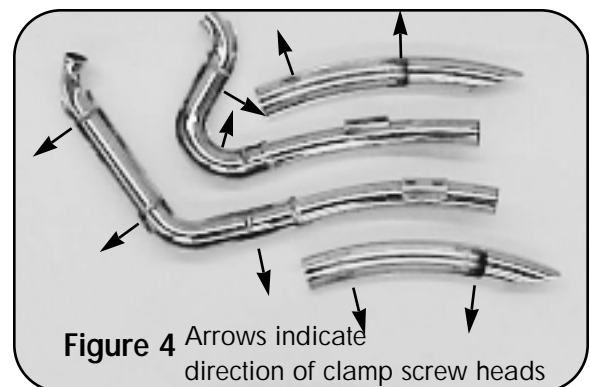

7. Install circlips and flanges from stock system onto new head pipes.
8. Using stock flange nuts, carefully install head pipes onto motorcycle. **NOTE:** Do not tighten at this time.
9. Use the nutplates and 5/16"x5/8" flange bolts (supplied) to attach the pipes to the bracket (Figure 5). **NOTE:** Do not tighten at this time.
10. Align pipes on motorcycle so that the gap between the two muffler bodies is consistent from front to rear and tighten exhaust port flange nuts (Figure 6). Tighten the 5/16"x5/8" flange bolts attaching mufflers to bracket.
11. Using the #28 hose clamps install the muffler heat shields (part # D308HC and D309HC) starting with D308HC on the front head pipe. Take note of screw head direction (Figure 4). Screw heads should be accessible when system is installed on motorcycle for adjustment purposes. **NOTE:** Do not tighten at this time.
12. Adjust the heat shields to get the best alignment at the seam where they touch and tighten all the hose clamps.
13. Check for adequate clearance between exhaust system and other motorcycle components.
14. **Be sure to tighten all hardware before starting motorcycle.**

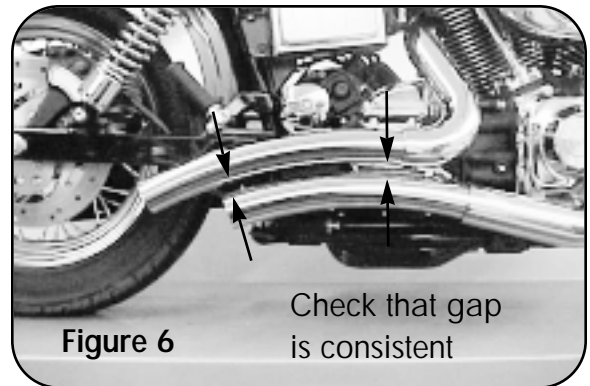
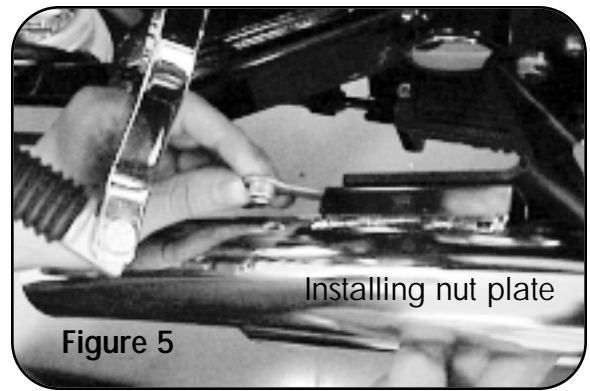

Option

On fuel injected models this system will work with Vance & Hines Fuelpak part number 61005. Order it today from your dealer or go to vanceandhines.com for more information.

RE-JETTING INSTRUCTIONS

Re-jetting the carburetors will result in realizing the "full" potential of this performance exhaust system. Vance & Hines offers jet kits for most applications. For fuel injected models, we recommend the use of Vance & Hines Fuelpak part number 61005.

PLEASE NOTE:

Every effort is made for Vance & Hines Exhaust Systems to provide improved cornering clearance. However, due to design and space limitations on some motorcycle models, ground and cornering clearance may not be improved and in some cases may be reduced. Be sure to follow proper installation instructions.

PACKING LIST (All parts actual size)

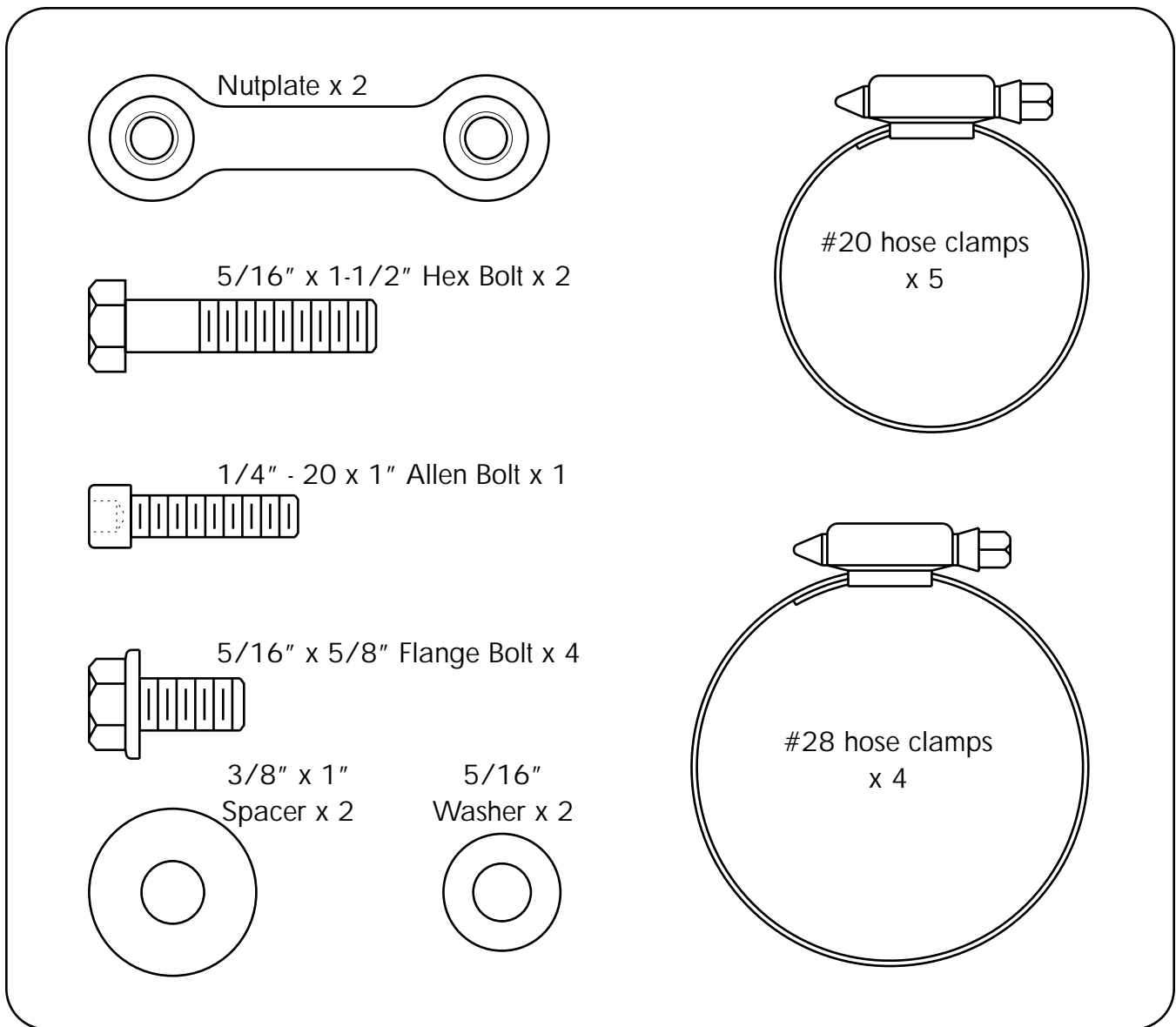

HELPFUL HINTS TO AVOID DISCOLORATION OF EXHAUST PIPES

1. Follow owner's manual instructions regarding use of the choke (starter enricher). If left on longer than recommended, discoloration may be accelerated.
2. Avoid long periods of idling.
3. Intake leaks can cause engine to run lean and overheat, thus turning the pipes blue.
4. Make sure there are no exhaust leaks at the junction of the exhaust pipe and cylinder head.
5. When installing a new set of chrome pipes, make sure your hands are clean and free of oil. After installation, thoroughly clean pipes with a cleaning solvent that will leave no residue (glass cleaner, alcohol, ammonia, etc.) before starting the motorcycle.

WARNING!

VANCE & HINES DOES NOT WARRANTY ANY CHROME PRODUCTS AGAINST DISCOLORATION.

For information on other Vance and Hines products visit our web site at www.vanceandhines.com