



MORE POWER : LESS NOISE



Congratulations, you have purchased the finest exhaust system for your motorcycle on the market. Your Vance & Hines exhaust system is designed and crafted for maximum performance, a perfect fit, a great sound and unbeatable style. Please follow the installation instructions below and if you have any questions, please call our technical support line at (562) 926-5291.

Attention installer (if other than owner), please forward this instruction sheet to the owner of this product. These instructions contain valuable information to the end user.

**TOOLS
REQUIRED**

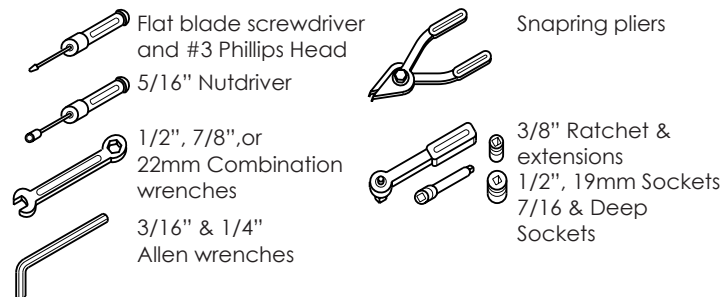

READ ALL INSTRUCTIONS BEFORE BEGINNING INSTALLATION

**STOCK EXHAUST
SYSTEM REMOVAL**

1. Remove seat to gain access to rear oxygen sensor connector. Unplug sensor and feed end of wire through frame so that it is free from motorcycle. NOTE: Pay attention to wire routing for re-installation.
2. Remove two bolts holding rectifier onto front of frame (near front tire). Open plastic cover to gain access to front oxygen sensor connector. Unplug sensor from harness and feed end of wire through to free it from motorcycle.
3. Loosen heat shield clamps on both the front and rear head pipes.
4. Remove front head pipe clamp bolt.
5. Remove the bolt that attaches rear head pipe clamp to mounting bar.
6. Remove two cylinder exhaust port flange nuts from each head pipe, located at the cylinder head.
7. Remove the complete exhaust system and set aside. Assistance may be required.
8. Remove stock mounting bar and the studs in the transmission cover.
9. Remove left bolt below the transmission cover. Position mounting bracket 1391-P over mounting location to determine which bolts to remove (Figure 1). Install this bolt in the top hole left vacant by the new bracket.
10. Carefully remove the flanges and circlips from the stock exhaust system using snapping pliers. NOTE: Replace bent or damaged circlips.
11. Remove stock exhaust gaskets and replace them with the supplied exhaust gaskets. NOTE: Replacement gaskets #22899 or HD Screaming Eagle #17048-98 or equivalent
12. Remove stock oxygen sensors and set them aside for they will be re-used on new system.

FIGURE 1

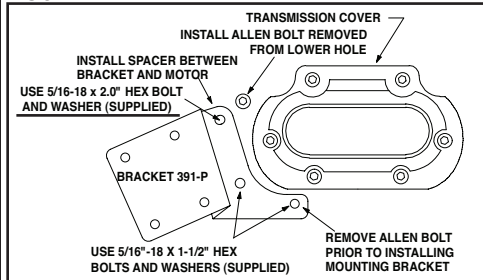

FIGURE 2

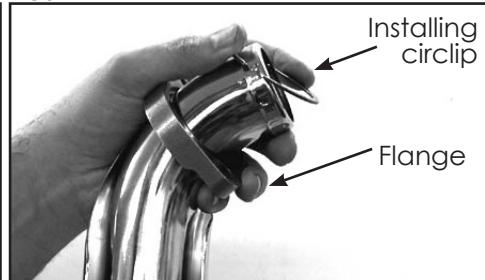

FIGURE 3

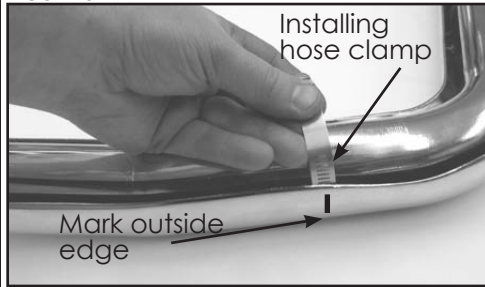

FIGURE 4

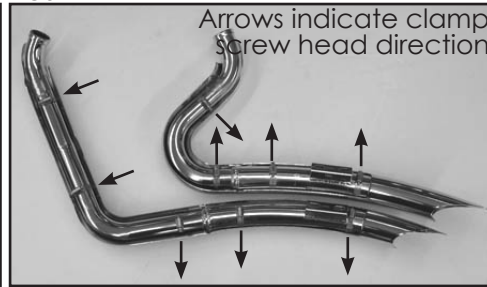
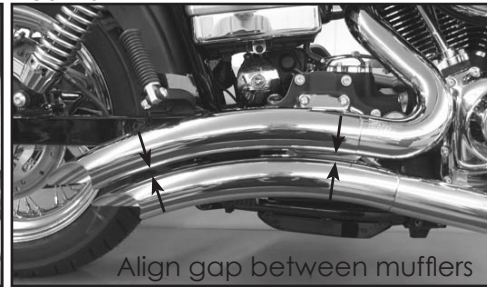

FIGURE 5



FIGURE 6



1. Attach mounting bracket 1391-P to transmission and tighten to 12-15 Ft/Lb torque. (Figure 1). NOTE: 2006 to 2007 models use three 5/16" x 1-1/2" hex head bolts and washers. 2008 to 2009 models use three 5/16" x 1-1/2" hex head bolt, washers, 11/16" spacer between the bracket and transmission in top hole.
2. Remove head pipes from their protective packaging and install circlips and flanges from the stock system onto both new head pipes (Figure 2).
3. Apply a small amount of anti-seize compound to the threads of the oxygen sensors and install them into the new head pipe.
NOTE: 2006 to 2009 models or models using 18mm wideband oxygen sensors install sensor directly into head pipe.
4. Remove heat shields from their protective packaging. Place each heat shield on a non-abrasive surface such as a blanket or carpet. Using a felt tip pen, mark outside edge of each heat shield to show location of hose clamp mounting clips (Figure 3).
5. Lay head pipes (D448FP & D449FP) into head pipe heat shields (D535HP & D538HP) respectively. Make sure alignment clip on head pipe fits inside heat shield. Loosely install #20 hose clamps by feeding tail end of clamp into heat shield clips (Figure 3). Take note of screw head direction (Figure 4). Screw head should be accessible when system is installed on motorcycle for adjustment purposes. NOTE: Do not tighten at this time.
6. Using stock flange nuts, carefully install head pipes into exhaust ports, starting with the rear cylinder. Assistance may be required. NOTE: Do not tighten at this time.
7. Slide nutplates inside brackets that are welded to backside of each muffler body (Figure 5). While holding nutplates in place, attach muffler bodies to mounting bracket 1391-P using four 5/16"x 5/8" flange head bolts (supplied). Leave them loose at this time.
8. Align pipes on motorcycle so that the gap between the two muffler bodies is consistent from front to rear and tighten exhaust port flange nuts (Figure 6).
9. Tighten flange bolts securing muffler bodies to mount bracket 1391-P.
10. Using the #28 hose clamps install the muffler heat shields with the D308HC on the front head pipe and the D325HP-S on the rear. Take note of screw head direction (Figure 4). NOTE: Do not tighten at this time.
11. Adjust the heat shields to get the best alignment at the seam where they touch (Figure 6) and tighten all the hose clamps.
12. Feed wire for front oxygen sensor through frame and into plastic holder on frame. Plug sensor into stock wiring connector. Snap plastic holder closed to hold connector in place.
13. Put toothed edge of wiring holder into slot in frame. Re-install rectifier so that it fits under tooth of wiring holder, keeping it in place in frame. Tighten both bolts.
14. Feed connector for rear oxygen sensor through frame and into underseat compartment. Plug sensor into stock wiring connector.
15. Re-install seat.
16. Check for adequate clearance between all exhaust system components and motorcycle accessories prone to heat damage.
17. Be sure to tighten all hardware before starting your motorcycle.
18. After installation and *before* starting motorcycle, completely clean pipes and mufflers with warm soapy water and a clean soft cloth that will not leave a residue. NOTE: Any residue, oil, or fingerprints will stain the chrome when the metal heats up.

EXHAUST CARE - HELPFUL HINTS TO AVOID DISCOLORATION OF EXHAUST SYSTEM

1. When installing a new set of coated pipes, make sure your hands are clean and free of oil. After installation, thoroughly clean pipes with warm soapy water and a soft cloth. Dry with clean towel to remove any residue (wax / polish, glass cleaner, alcohol, ammonia, etc...) before starting the motorcycle.
2. Avoid long periods of idling as this can cause discoloration.
3. Intake leaks can cause the engine to run lean and overheat, this could lead to discoloration.
4. Make sure there are no exhaust leaks at the junction of the exhaust pipes and cylinder head. We recommend replacing gaskets if they are worn.

VANCE & HINES OPTIONAL ACCESSORIES

FUELPK

Quiet Baffle #23081
FP4 #66047

PLEASE NOTE: Every effort is made for Vance & Hines Exhaust Systems to provide improved cornering clearance. However, due to design and space limitations on some motorcycle models, ground and cornering clearance may not be improved and in some cases may be reduced. Be sure to follow proper installation instructions.



PACKING LIST

MORE POWER : LESS NOISE

ALL PARTS SHOWN ARE ACTUAL SIZE

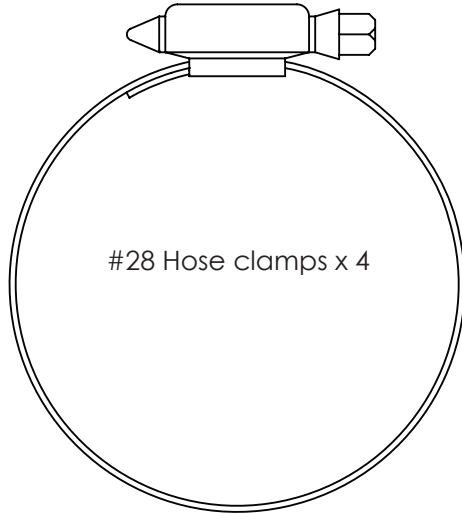

#28 Hose clamps x 4

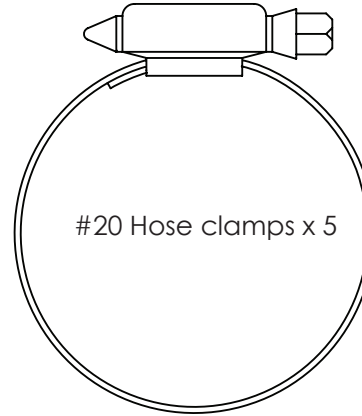

#20 Hose clamps x 5

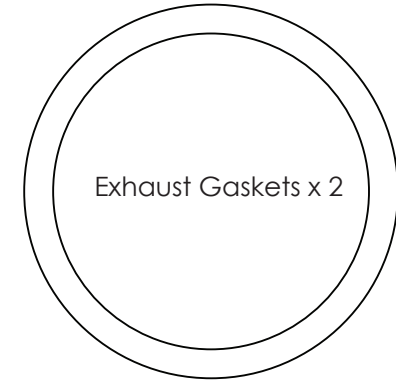

Exhaust Gaskets x 2

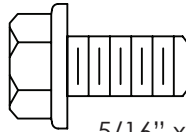

5/16" x 5/8" Flange head bolts x 4

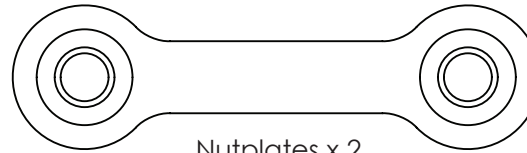

Nutplates x 2

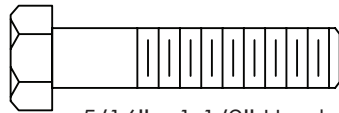

5/16" x 1-1/2" Hex head bolts x 3

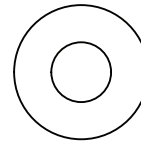

5/16" Flat washers x 3

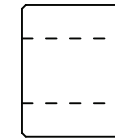

1 1/16" x 9/16"
 Spacer x 1

PARTS NOT SHOWN:

| | | |
|----------|---------------------------|-----|
| 1391-P | Bracket | x 1 |
| D448FP | Front head pipe assy | x 1 |
| D449FP | Rear head pipe assy | x 1 |
| D535HP | Front heat shield | x 1 |
| D538HP | Rear heat shield | x 1 |
| D322HP-S | Front muffler heat shield | x 1 |
| D325HP-S | Rear muffler heat shield | x 1 |

WARRANTY

Vance & Hines exhaust systems are warranted against defects in material and workmanship for a period of 90 days from the date of purchase from an authorized dealer. This warranty does not cover discoloration of chrome finishes. This warranty is limited to the repair or replacement of a product proven to be defective from normal use. Vance & Hines exhaust systems are designed to fit and operate on OEM motor and chassis. This warranty does not cover any product subject to abuse, misuse, improper installation or modification.



Connect. Tune. Ride.

From the team that brought you The Fuelpak FP3, the best-selling ECU tuner in the world for Harley-Davidson motorcycles, the Vance & Hines FP4 is the most intuitive tuning tool on the market, giving you the power to control your motorcycle's tune and offers the best-in-industry support from our FP4 technicians, all from your smartphone.

- Download and Flash Maps
- Live Data Viewing
- Autotune Feature for Map Customization

Visit vanceandhines.com to learn more about FP4.

Qualified Manufacturer Declared 49-state Federal Emissions Compliant Part.



Emissions Notice:

In California, in order to meet Air Resources Board emissions requirements, certain aftermarket part applications have been identified as replacements, and others have received ARB Executive Orders. All other emissions related aftermarket parts are for competition use only. A list of replacement parts and EO parts, and corresponding fitment is provided at vanceandhines.com/California.

Warranty:

All Vance & Hines products are warranted against defects in material and workmanship for a period of 90 days. This warranty does not cover discoloration or rust. This warranty shall be limited to the repair or replacement of the product, which may be proven defective under normal use. Vance & Hines will not warranty any system that has been abused, misused, improperly installed or modified.

Dealers or distributors are not authorized to make dispositions binding upon Vance & Hines. Vance & Hines will not be responsible for any labor charges incurred in removing or replacing any system under warranty. A return authorization number and a copy of the original purchase invoice must accompany all returns. Parts returned without a return authorization may be refused.